

Hafa® Go, Style

Art.nr 1580300, 1580310, 1391134,
1391139, 1391150, 1391151

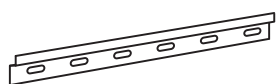

1 x a

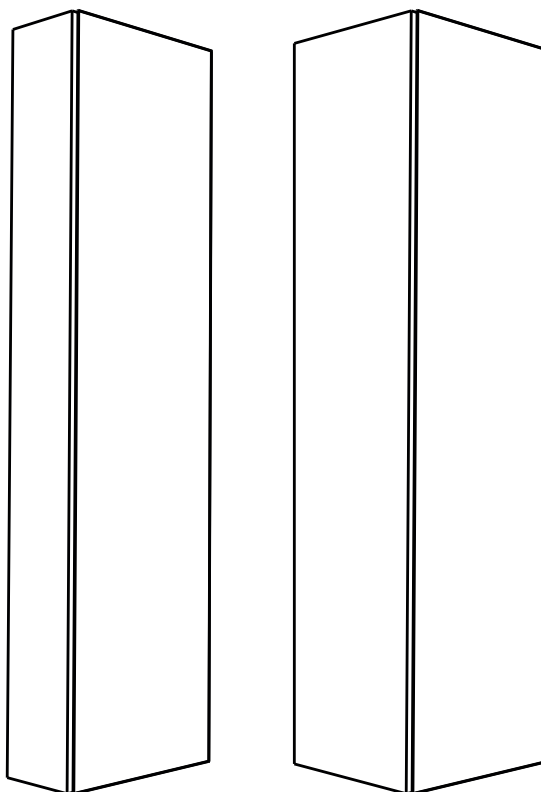

1 x b



3 x c



16 x d



38 x e

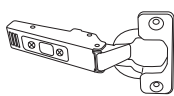

1 x f



6 x h

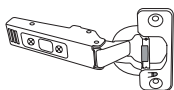

2 x g



PH2
PZ2



SILICONE

Hafa®

Hafa
Svarvaregatan 5, Box 525
SE-301 80 Halmstad
SWEDEN

Garanti/Warranty
Service, reservdelar/spare parts

Sweden: Tel: +46 (0)35 15 44 75
Norway: Tel: +47 (0)69 31 02 30
Finland: Puh: +358 (0)20 743 57 40

www.hafa.se
www.hafa.dk
www.hafabad.no
www.hafa.eu

E-mail:
info@hafa.se
info@hafabad.dk
info@hafabad.no
info@hafa.fi

1

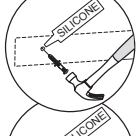
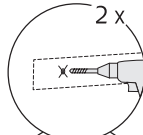
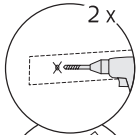
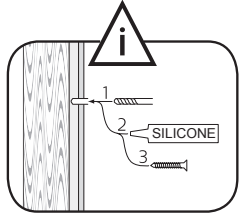
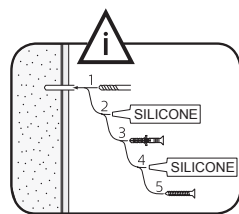
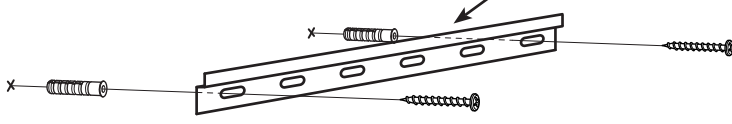
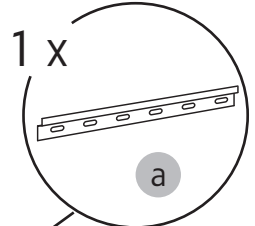
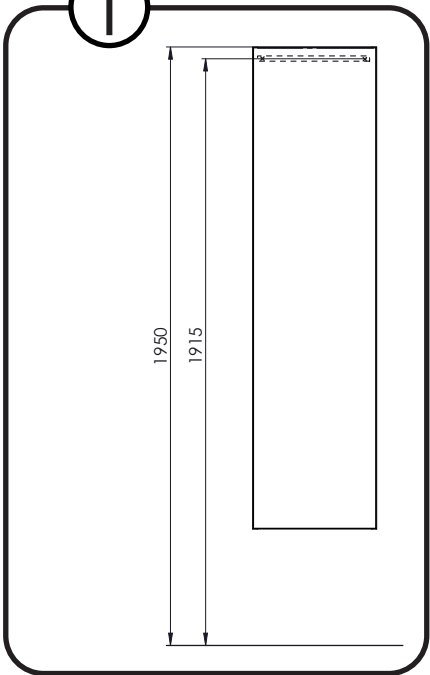

OBS! Använd skruv som passar ditt väggmaterial
 OBS! Brug den skrue, der passer til dine vægmaterialer
 OBS! Bruk skruer som passer til veggmaterialet
 HUOM! Käytä seinämateriaaliin sopivaa ruuvia
 NOTE! Use screws suitable for your wall material

Läs mer på sid 6
 Read more on page 6

2

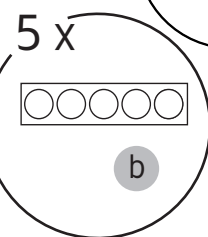
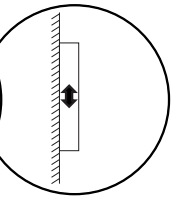
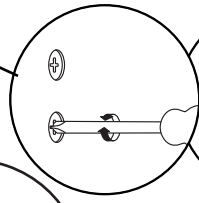
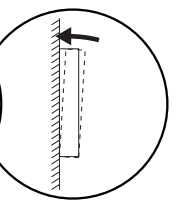
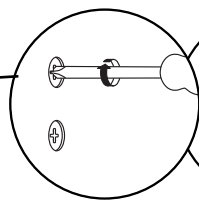
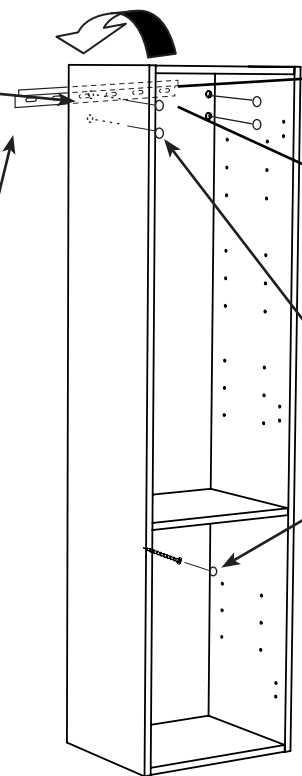
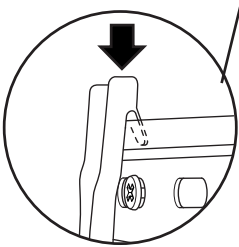
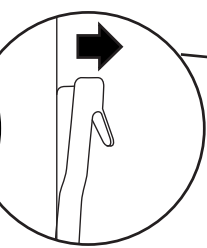
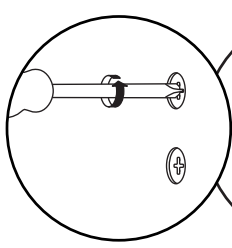

3

i

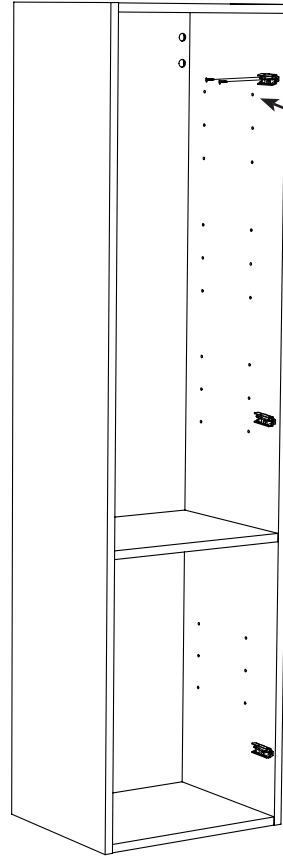
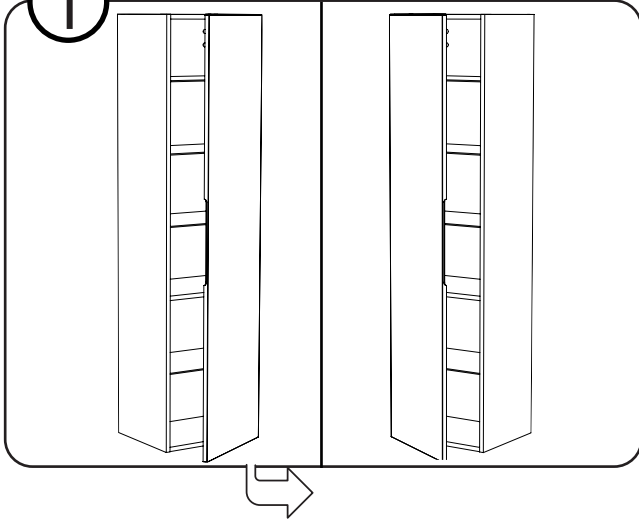

3 x

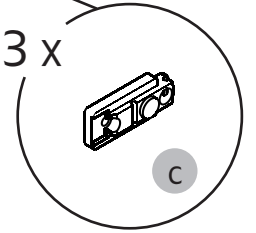

4

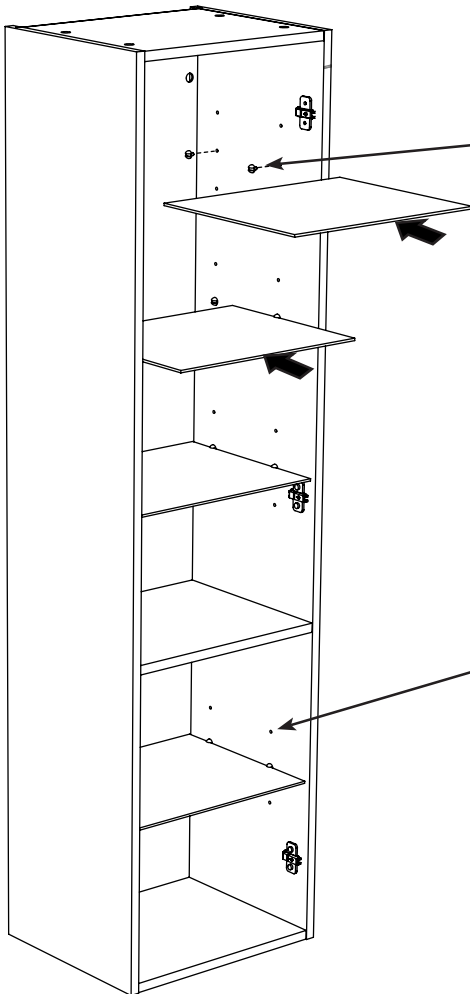

16 x

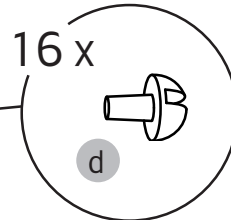

38 x

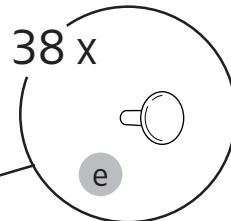

5

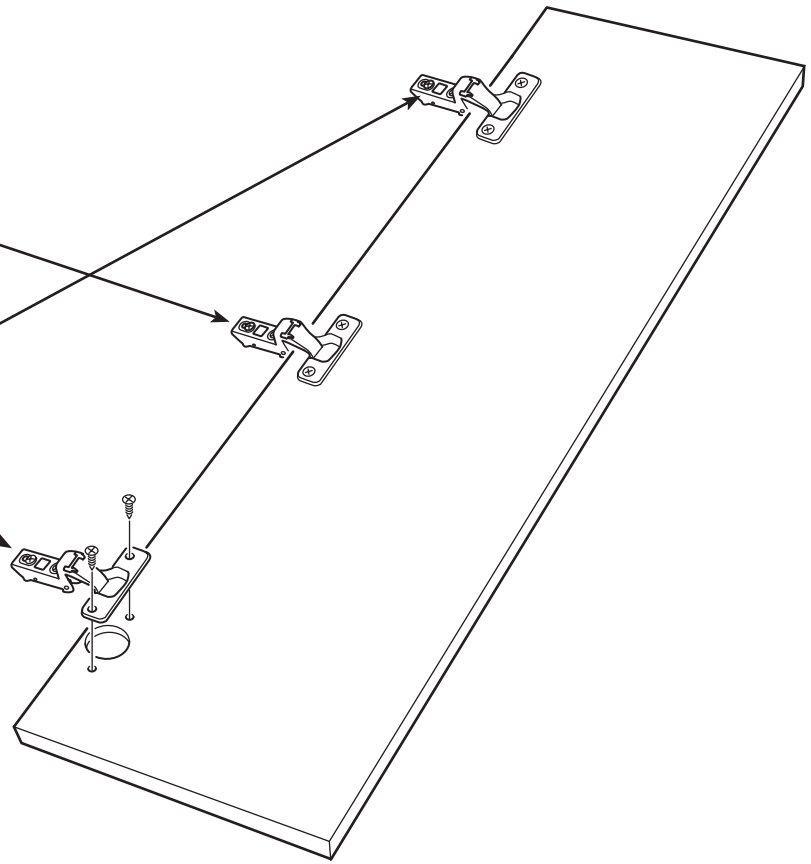
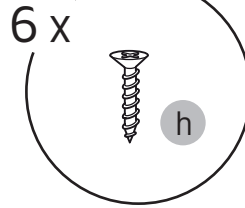
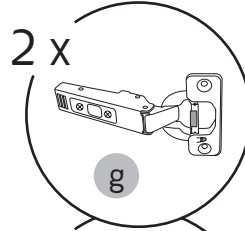
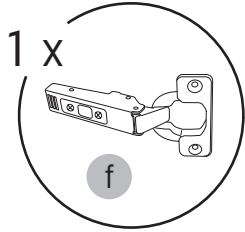

6

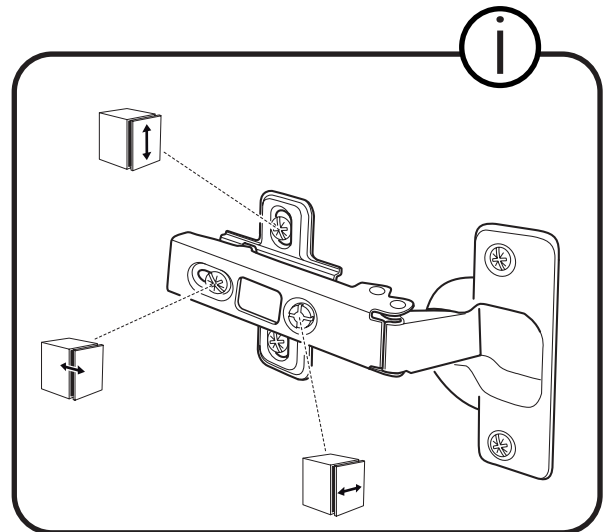
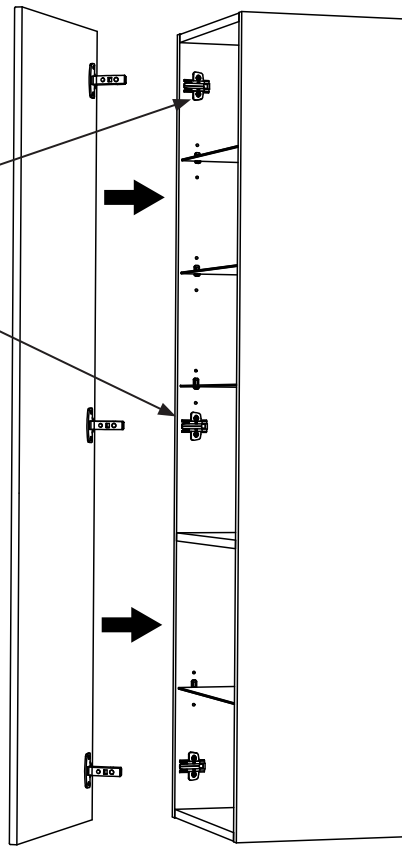
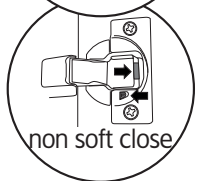
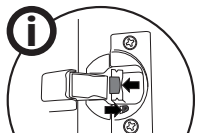
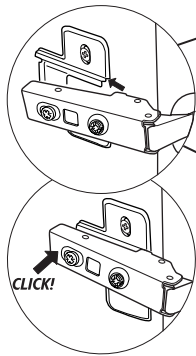

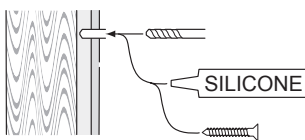

alt.

SE

Skruvinfästningar ska göras i betong eller annan massiv konstruktion, träreglar, träkortlingar eller i konstruktion som är provad och godkänd för infästning, till exempel skivkonstruktion. Se exempel på godkända konstruktioner på sakervatten.se. Material för tätning ska fästa mot underlaget och vara vattenbeständigt, mögelresistent och åldersbeständigt. Krav på tätning gäller både i våtzon 1 och 2.

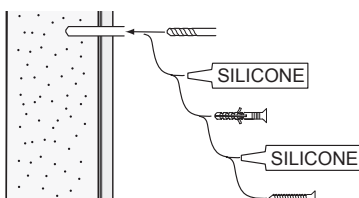

GB

Below are Swedish recommendations:

Screw fastenings should be made in concrete or other solid structure, wooden studs, wooden noggings or in structures that have been tested and approved for fastenings, for example a sheet construction. See examples of approved constructions at sakervatten.se. Sealing substances must fixate to the materials it aims to seal, be waterproof, mould-resistant and age-resistant. Requirements for sealing apply in wet zones 1 and 2.

Hafa[®]

Hafa
Svarvaregatan 5, Box 525
SE-301 80 Halmstad
SWEDEN

Garanti/Warranty
Service, reservdelar/spare parts

Sweden: Tel: +46 (0)35 15 44 75
Norway: Tel: +47 (0)69 31 02 30
Finland: Puh: +358 (0)20 743 57 40

www.hafa.se
www.hafa.dk
www.hafabad.no
www.hafa.eu

E-mail:
info@hafa.se
info@hafabad.dk
info@hafabad.no
info@hafa.fi